

ComatReleco Motorcontroller CMC1

1 Features

- Power supply DC 12...24 V
- Motor current 16 A in continuous duty, temporary 20 A
- Adjustable start and breaking ramps
- Status and error display by LED
- Short-circuit-proof
- Wear free



2 General description

The CMC1 is a control device for DC motors and permits operation in both rotating directions, i. e. the rotating direction can be reversed with the input signal. Alternatively, two motors can be operated in one rotating direction. The CMC1 allows also controlling electromagnets, simple motion sequences of lifting spindles, small conveyor belts, shutters or lamps. The ramp time for accelerating or decelerating behavior of the load can be adjusted by two potentiometers. Mechanical shock or high current peaks in the power supply are avoided; the life time of the entire system is thereby extended.

The CMC1 complies with the applicable DIN standard 43880 and has an installation dimension of 14 mm.

Technical specification is subject to change without previous notice.

3 Order designation

ComatReleco Motor Controller CMC1/DC12-24V

4 Connection diagram

Terminal	Function
I1	Input 1
I2	Input 2
GND	Ground of control signals
Q1	Output 1
Q2	Output 2
+, -	Power supply

Galvanic separation between inputs, power supply and outputs.

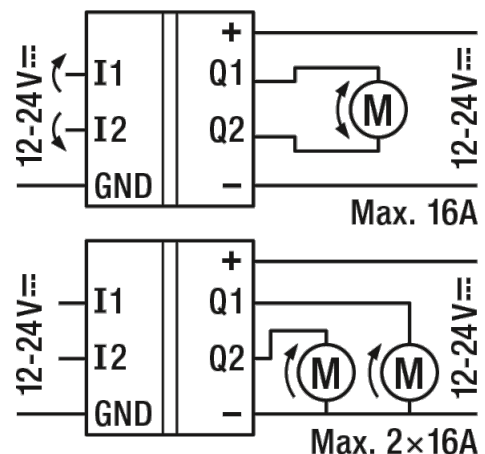

5 Function description

When triggering an input I1 or I2, the motor is moving forward or backward. The time slots for the acceleration and the deceleration are adjustable by the two potentiometers. Exceeding current or torque peaks are avoided due to controlled acceleration and deceleration. The voltage at the load is adjusted very low-loss by pulse width modulation. The power output stage is protected against short-circuit and overheating. Errors are displayed by LED.

5.1 Operation with acceleration and deceleration ramp (Motors)

Ramp time $t > 0$ s

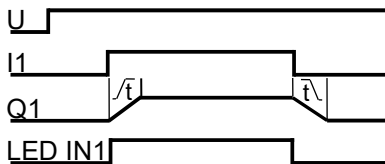

When triggering the input I1, the voltage on output Q1 will be raised to the nominal value linearly during the preset time slot. The motor is accelerated to full speed.

If input I1 is switched off, the voltage at output Q1 is shut down linearly to zero during the preset time slot. The motor is decelerated to a halt.

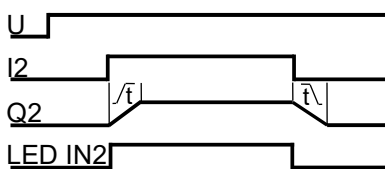

When triggering the input I2, the voltage on output Q2 will be raised to the nominal value linearly during the preset time slot. The motor is accelerated to full speed.

If input I2 is switched off, the voltage at output Q2 is shut down linearly to zero during the preset time slot. The motor is decelerated to a halt.

5.2 Normal activation and deactivation (Lamps, electromagnets)

Ramp time $t = 0$ s

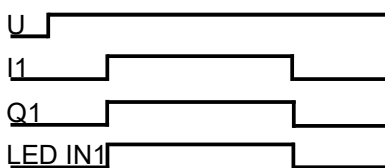

Triggering the input I1 switches on the output Q1 (e.g. electromagnet) immediately.

If the input I1 is de-energized, the output Q1 is instantly switched off.

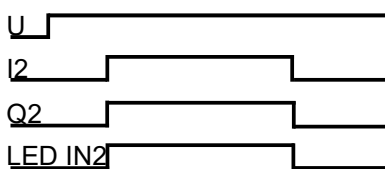

Triggering the input I2 switches on the output Q2 (e.g. electromagnet) immediately.

If the input I2 is de-energized, the output Q2 is instantly switched off.

6 Specifications

6.1 General data

6.1.1 Mechanical data

Housing	System DIN
Outside dimension (W x H x D):	14 x 90 x 63 mm
Fastening	DIN Rail TS35
Connection	Screw terminal 2.5 mm ²
Ingress protection degree	IP20
Case material	Aluminum
Weight	80 g

6.1.2 Ambient conditions

Storage temperature range	-40 °C ... +85 °C
Operating temperature range	-25 °C ... +70 °C
Relative humidity	10 % ... +95 % (non condensed)

6.1.3 Life cycle

Expected life time (MTTF)	100 000 h (at 25 °C)
---------------------------	----------------------

6.2 Electrical data

6.2.1 Power supply +, -

Nominal voltage	12 ... 24 V DC
Admissible voltage range	8 ... 28 V DC
Current consumption without load max.	10 mA
Power consumption without load at 12 V max.	120 mW
Power consumption without load at 24 V max.	240 mW

6.2.2 Inputs I1, I2

Nominal voltage	12 ... 24 V DC
Admissible voltage range	8 ... 28 V DC
Current consumption at 12 V max.	3 mA
Current consumption at 24 V max.	6 mA

6.2.3 Outputs Q1, Q2

Nominal voltage	12 ... 24 V DC
Output	MOSFET H-bridge
Nominal current (40 °C max.)	16 A
Inrush current (3 s max.)	20 A
Switching current 24 V DC-1, DC-13	16 A
Switching current 24 V DC-3, DC-5	10 A

6.3 Time response

6.3.1 Ramps

Start ramp	0 ... 4 s
Breaking ramp	0 ... 4 s

6.4 Diagrams

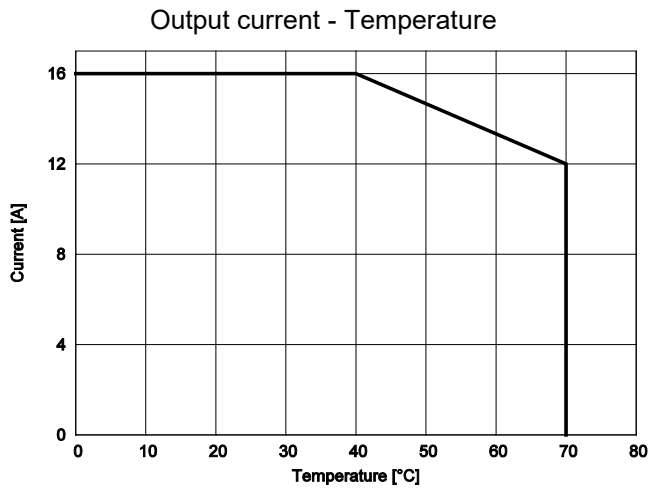

7 Application

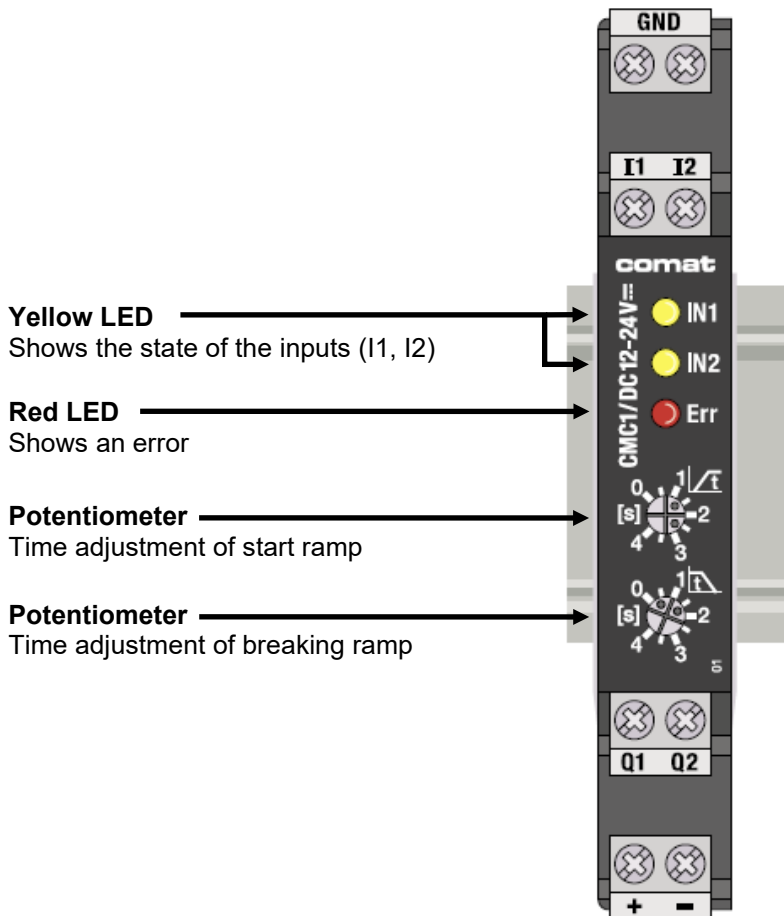

7.1 Function display

Element	Function (one load)	Function (Two loads)
Poti	Ramp time acceleration 0...4 s	Ramp time acceleration 0...4 s
Poti	Ramp time deceleration 0...4 s	Ramp time deceleration 0...4 s
LED IN1	Control input I1 on, motor in motion e.g. forward	Control input I1 on, motor 1 is on
LED IN2	Control input I2 on, motor in motion e.g. backward	Control input I2 on, motor 2 is on
LED Err (Error)	Error detected, see chapter 7.2 Error display	Error detected, see chapter 7.2 Error display

7.2 Error display

LED Err (red)	Status	Troubleshooting
Not illuminated	Normal operation	
Illuminated at power-on	Output current too high (> 18 A)	Reduce the load, extend the acceleration ramp
Blinking	Output stage overheated	Cool down (> 10 s), switch off inputs, reduce the load

8 Dimension

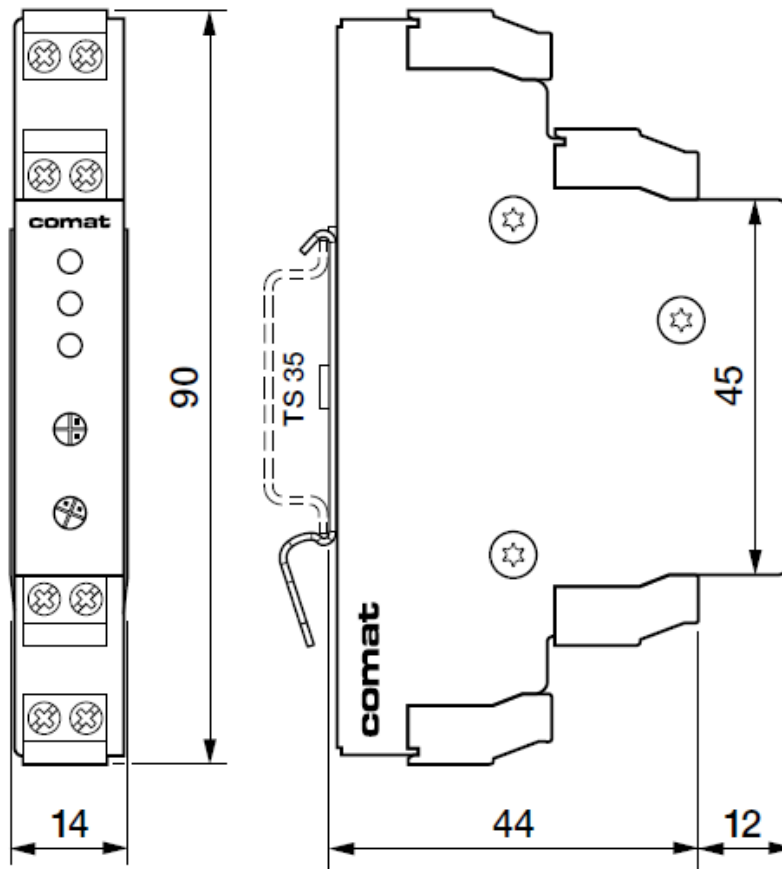

9 Standards

Interference immunity

EN 61000-6-2:2005
 EN 61000-4-2:2001 Level 3 (Air: 8 kV)
 EN 61000-4-4:2004 Level 3 (2 kV)
 EN 61000-4-5:2006 (100 V)

Interference emission

EN 61000-6-3:2007
 EN 55022:2006 Class B

Safety

EN 60730-1:2000

Conformities, identifications

CE

10 Revision history

Version	Revision date	Responsible	Realized modifications
55082-02-57-401	01.07.2011	Bd, Cp, Sa	Version 1
55082-002-57-002	06.05.2014	Vs	New Layout
55082-002-57-003	13.03.2015	Mi	Increased output current of 16 A from lot code 1503