

RAC25-220/UC24V

2 pole | 25 A | 5.4 kW | Manual lever Auto - 1 - Lock



Main circuit

Available contact materials	⚡ AgNi
Rated voltage	400 V AC
Rated current AC-1	25 A
Recommended minimum contact load	50 mA, 17 V
Inrush current	60 A, 100 ms / 280 A, 300 μs
Rated load AC-1	5.4 kW
Rated load AC-3	1.3 kW
Rated load DC-1	see fig. 2
Mechanical endurance (cycles)	≥ 10 000 000
Electrical endurance at rated load AC-1 (cycles)	≥ 200 000
Electrical endurance at rated load AC-3 (cycles)	≥ 500 000
Electrical endurance at rated load DC-1 (cycles)	≥ 100 000
Switching frequency at rated load AC-1 (cycles / h)	≤ 600
Switching frequency at rated load AC-3 (cycles / h)	≤ 600
Switching frequency at rated load DC-1 (cycles / h)	≤ 300

Control circuit

Nominal voltage	see table product references
Operating voltage range	0.85 ... 1.1 U _N
Pick-up voltage	≤ 0.85 U _N
Release voltage	≥ 0.1 U _N
Pick-up time	15 ... 45 ms
Release time	20 ... 70 ms
Power consumption AC / DC	2.6 VA / 2.6 W
Frequency range	40 ... 500 Hz

Insulation

Rated insulation voltage	440 V
Rated impulse withstand voltage open contact	4 kV / 1 min
Pollution degree	3
Overvoltage category	III
Clearance of open contact	3.6 mm

Wiring

Contact type control / main circuit	Screw connection M3 / M3.5
Conductor cross section control / main circuit	2.5 mm ² / 6 mm ²
Stripping Length control / main circuit	7 mm / 9 mm
Nominal screw torque control / main circuit	0.6 Nm / 1.2 Nm
Screwdrive control / main circuit	PZ1 / PZ1
Max. wire count control / main circuit	1
Dual sleeve control / main circuit	1

Housing and environmental conditions

Storage temperature (no ice)	-40 ... 80 °C
Operation temperature	-15 ... 55 °C
Relative humidity, no condensation	95 % relative humidity
Ingress Protection	IP 20
Weight	250 g
Housing material	PA 6
Operation Altitude	Max. 2 000 m
Mounting	DIN rail
Dimensions	85 x 35 x 65 mm
Vibration test	switched off: 2 g (Z and X axis) / switched on: 3 g (Z axis) and 1 g (X axis)
Shock test	switched off: 10 g (Z and X axis) / switched on: 15 g (Z axis) and 2 g (X axis)

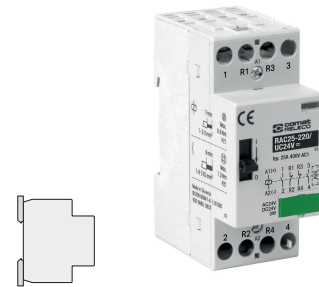

fig. 1. Wiring diagram

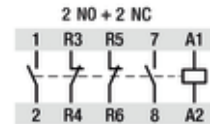

fig. 2. DC load limit curve

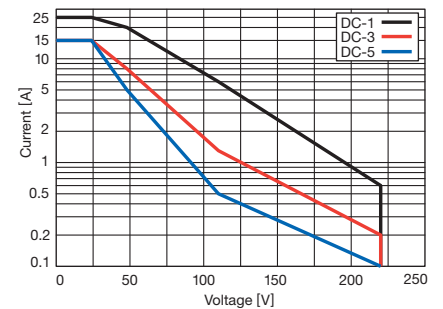
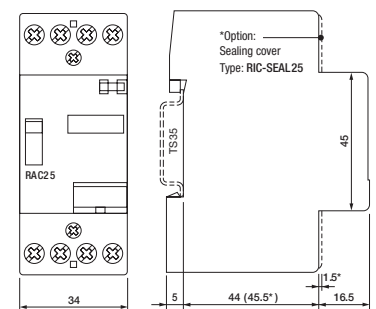

fig. 3. Dimensions (mm)



Technical approvals, conformities

Standards IEC/EN 60947; IEC/EN 61095

Approvals

RAC25-220/UC24V

2 pole | 25 A | 5.4 kW | Manual lever Auto - 1 - Lock



Safety

MTTF - Mean time to failure, AC-1 (h)	4.166
MTTF = $1/\lambda = B10/(0.1 n_{op})$, AC-3 (h)	10.416
MTTF _d - Mean time to failure dangerous, AC-1 (h)	5.555
MTTF _d = $1/\lambda = B10_d/(0.1 n_{op})$	13.888
B10 - Number of operating cycles until 10 % of devices fail, AC-1	150,000
B10 - Number of operating cycles until 10 % of devices fail, AC-3	375,000
B10 _d - Number of operating cycles until 10 % of devices fail dangerous, AC-1	200,000
B10 _d = B10/ratio of dangerous failures, AC-3	500,000
λ - Failure rate, AC-1 (1/h)	0.00024
$\lambda = (0.1 n_{op})/B10$, AC-3 (1/h)	0.000096
λ_d - Failure rate dangerous, AC-1 (1/h)	0.00018
$\lambda_d = (0.1 n_{op})/B10_{op}$, AC-3 (1/h)	0.000072
Ratio of dangerous failures (%)	75
n_{op} - Operating cycles (operating cycles/h)	360

Product references

Description	Type	24
2 NO + 2 NC	RAC25-220/UC...V	✓

Other voltages on request. Please contact support@comatreleco.com.
«...» List control circuit voltage to complete product references.

Accessories

Sealing cover	RIC-SEAL25
Spacer	RIC-DIST
Busbar	RIC-NS-2-1, RIC-PS-2-3, RIC-PS-2-4
End covers	RIC-EK-11 (BAG 25 PCS), RIC-EK-23 (BAG 10 PCS), RIC-EK-40 (BAG 10 PCS)
Auxiliary contact	RIC-AUX02, RIC-AUX11, RIC-AUX20

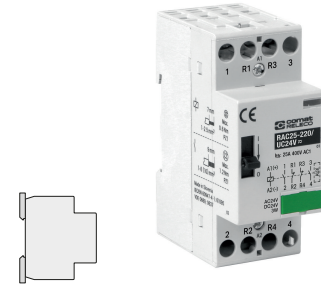

fig. 1. Wiring diagram

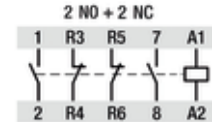

fig. 2. DC load limit curve

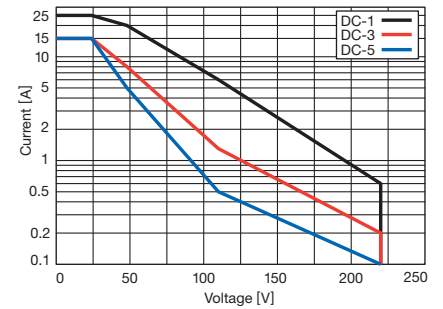
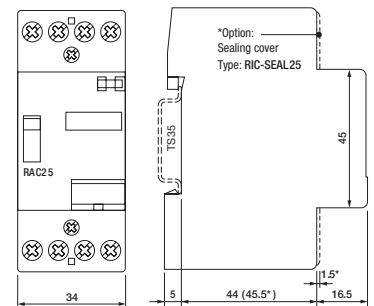

fig. 3. Dimensions (mm)



Technical approvals, conformities

Standards IEC/EN 60947; IEC/EN 61095

Approvals